

eduard  
MASK

# He 111H-6

The die-cut mask for accurate canopy frame painting of the  
*Hasegawa* 1/72 KIT

CX 003

16

17

13

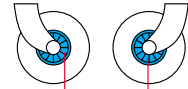
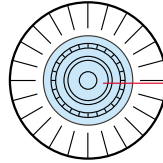
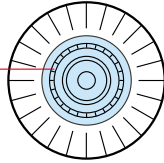

2 pcs.

2 pcs.

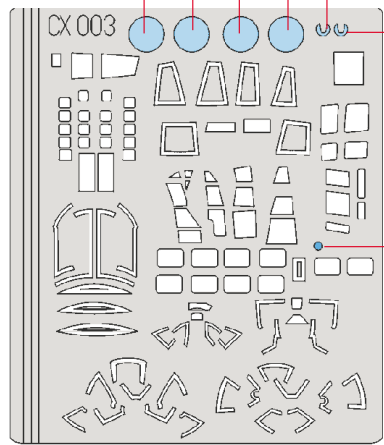
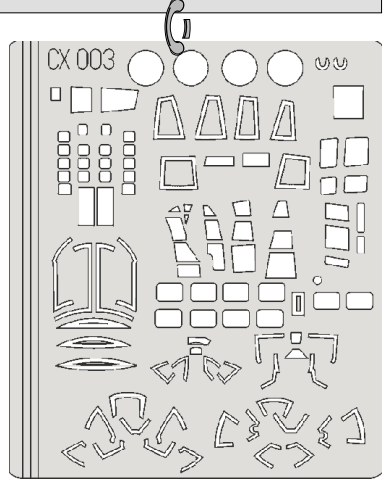

N10

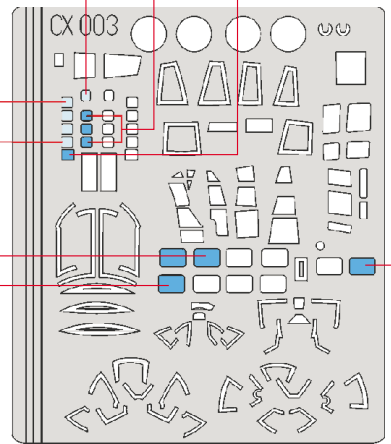
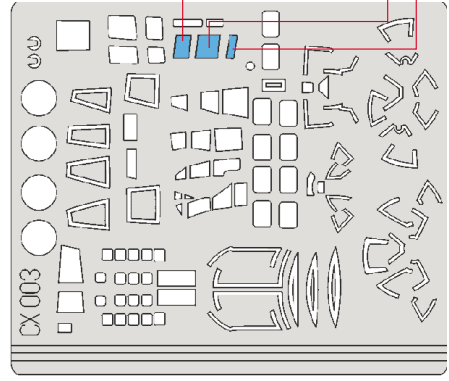
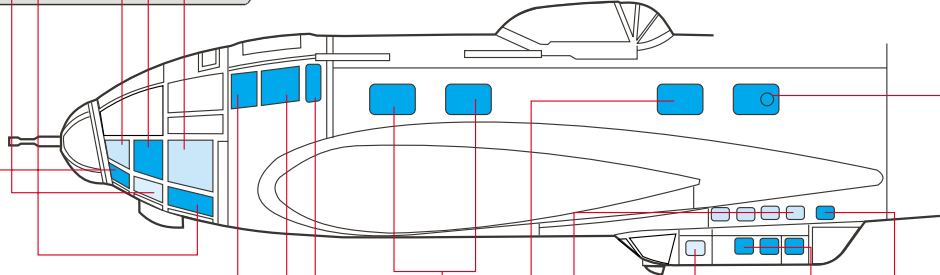
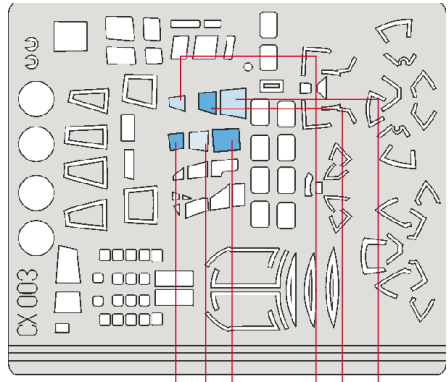

 LIQUID MASK

**REFERENCES:**  
Aero Detail No.18 - Heinkel He 111  
Modelpres Publ. - Heinkel He 111  
Replic No.40 12/1994

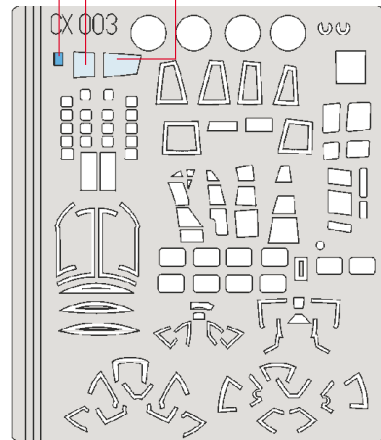
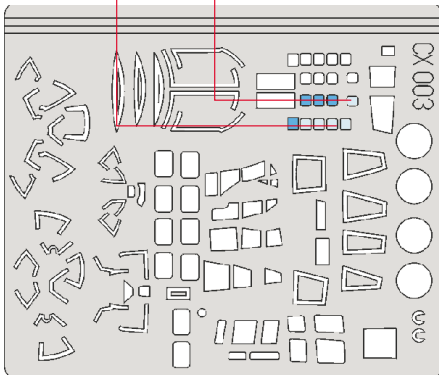
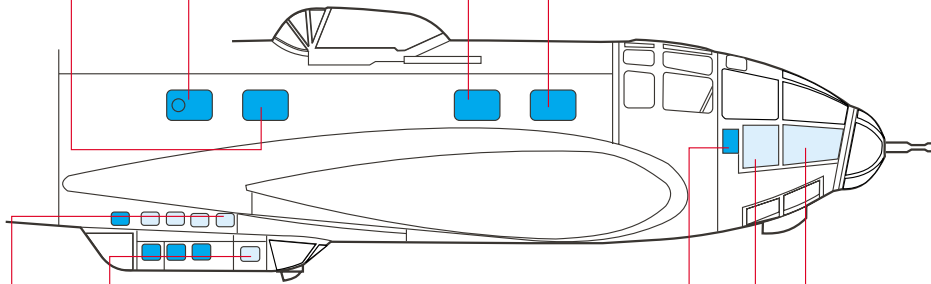
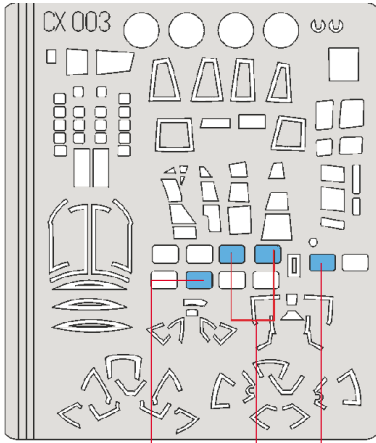

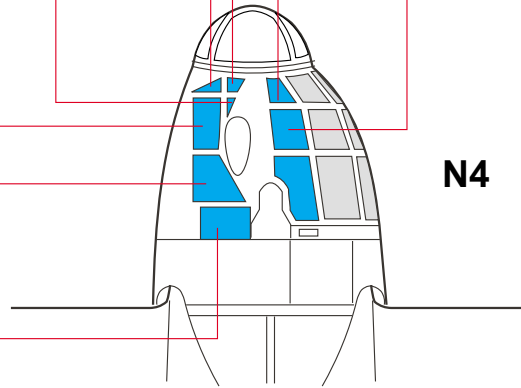
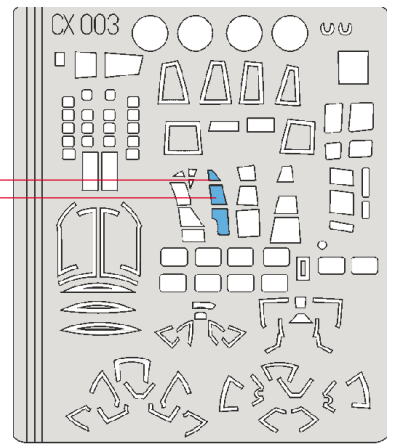
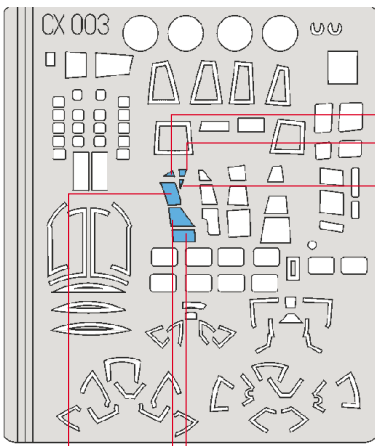

1.)

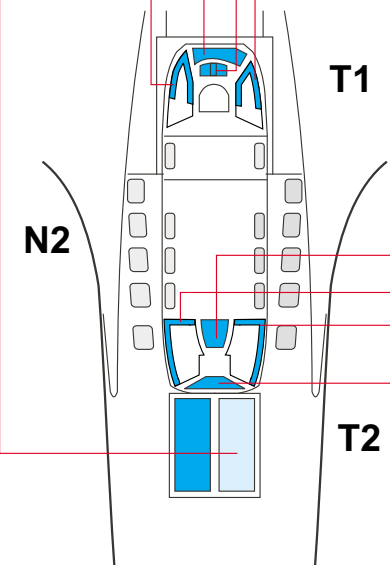
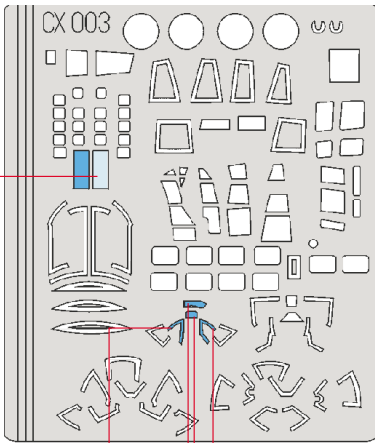

2.)

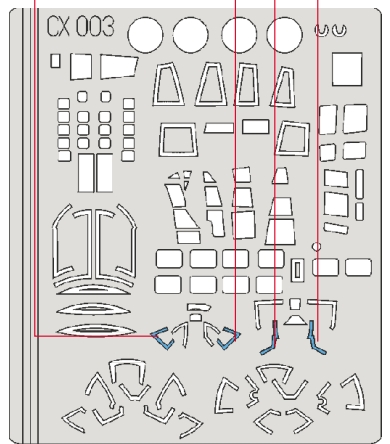
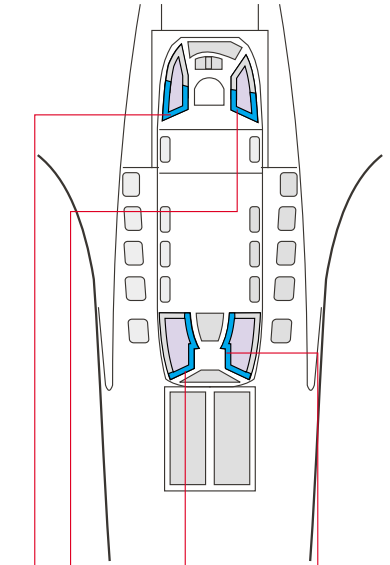

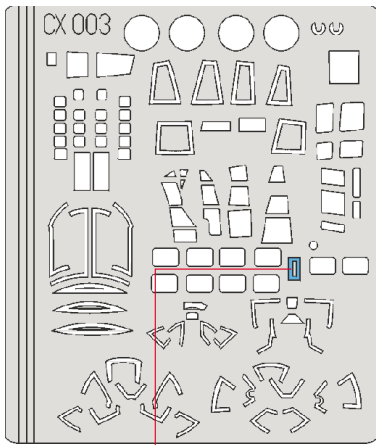

LIQUID MASK

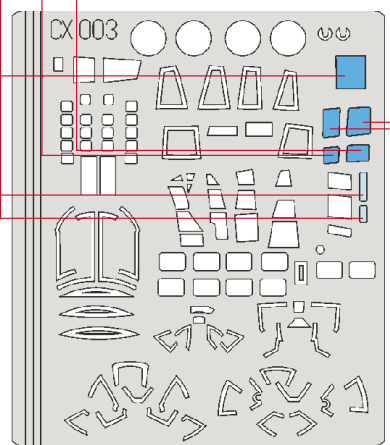
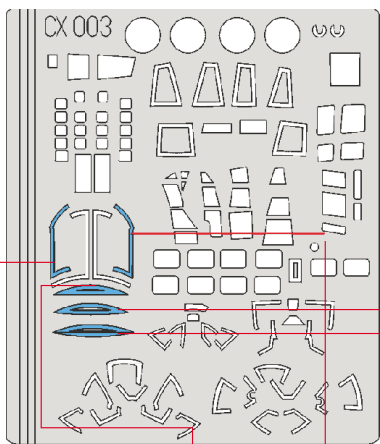
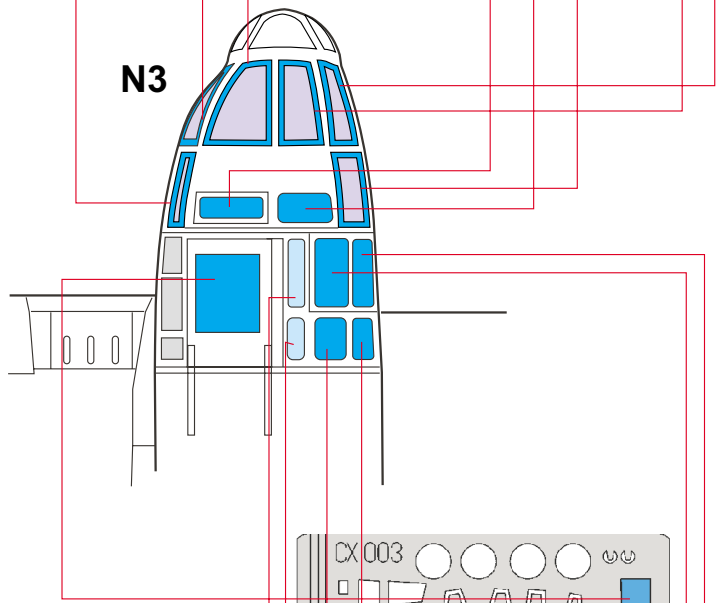
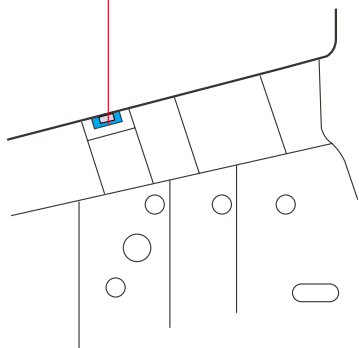
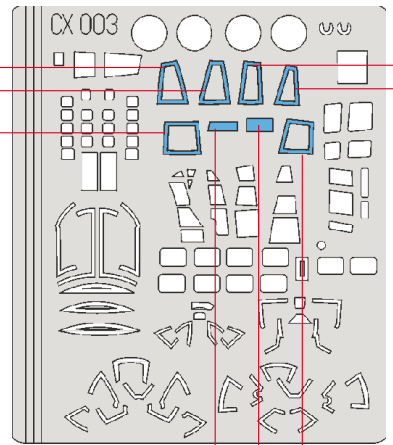

1.)

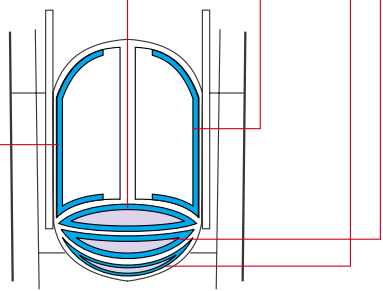

2.)

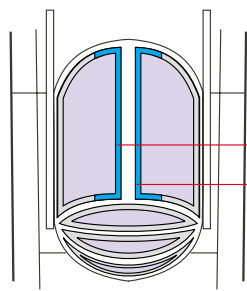

T3

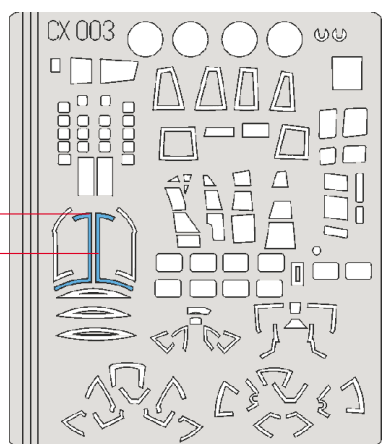

1.)

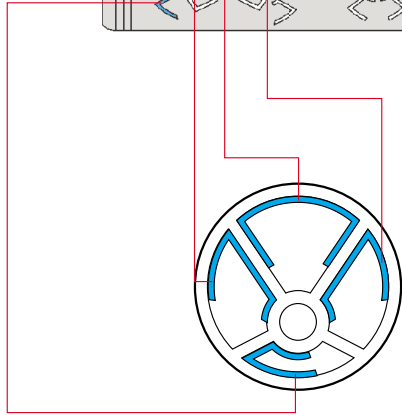
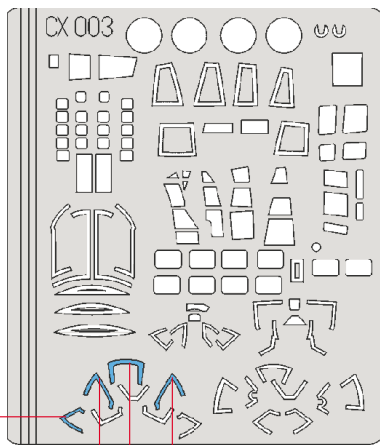

N14

2.)

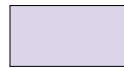
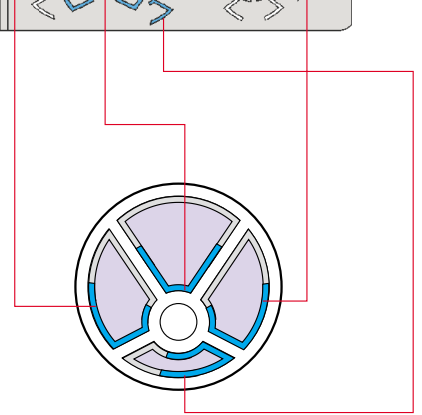
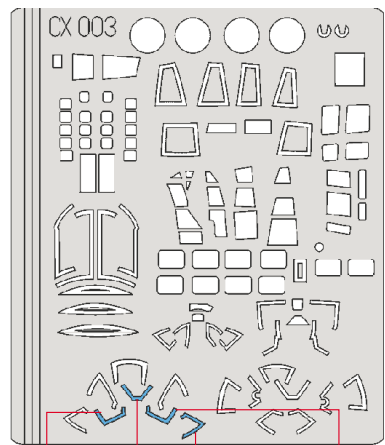

LIQUID MASK

1.)

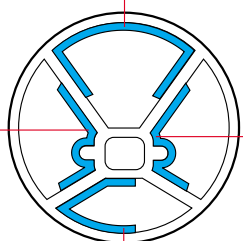
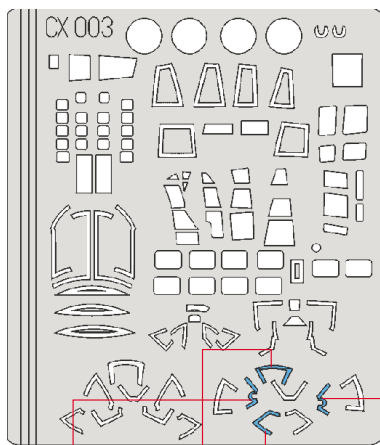

N15

2.)

